

# Dosing technology

## Dosing system

**preeflow®** *eco-DUO450*  
by ViscoTec

### DESCRIPTION

The new and innovative 2-K-precision-volume-dispenser eco-DUO 450 made by ViscoTec offers a wide range of applications for the 2-component dispensing.

### FUNCTIONAL THEORY

preeflow® eco-DUO is a rotating and perfectly pressure-tight displacement system. Self-sealing rotor/stator design. Conveyance action by medium displacement in the stator through controlled rotor movement. Safe conveyance without any modification of the medium. With its suck back option, preeflow® ensures clean and controlled material or medium cut-off while preventing post-dripping effects.

### APPLICATION

On-the-dot dosage with maximum volumetric precision – dot-and-bead application with application speeds adaptable to track speeds – joint sealing technology.

### RANGE OF USES

- electronic packaging
- semiconductor
- LCD/LED/OLED
- photovoltaic
- medica
- biological chemistry
- laboratory
- optics and photonics
- SMD/SMT

### TECHNICAL FEATURES

- genuine volumetric dosing
- viscosity-independent dosing
- primary pressure-independent dosing
- pressure-tight no valve
- suck back effect
- easy to clean
- controllable dosing flow
- range of dosing pressures up to 40 bar

eco-DUO450



# preeflow<sup>®</sup> eco-DUO450

by ViscoTec

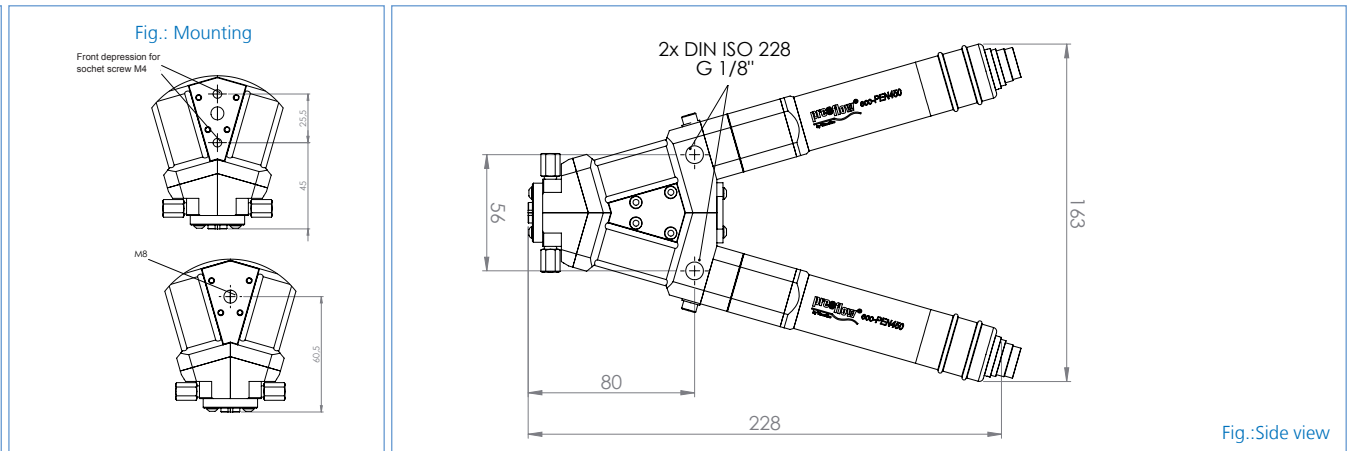

## TECHNICAL DATA

Weight:	approx. 1100 gram
Material infeed:	1/8" cylindrical whitworth pipe thread DIN/ISO 228
Material outfeed:	static mixer with bayonet socket
Min. operating pressure:	0 bar, self-levelling-fluid
Max. operating pressure:	0 to 20 bar input pressure, non-self-levelling-fluid
Max. dosing pressure <sup>(4)</sup> :	up to 40 bar
Intrinsic tightness <sup>(1)</sup> :	approx. 2 bar (reference medium approx. 10mPas at 20°C)
Parts in contact with the media:	aluminum, anodized
Seals:	High-molecular PE, VisChem
Static seals:	Viton O ring
Motor:	18 - 24 V DC, incremental encoder, planetary gears
Operating conditions:	+10°C to +40°C, air pressure 1 bar
Medium temperature:	+10°C to +40°C
Approx. dosing volume per revolution:	0.05 millilitres per revolution
Accuracy of dosing <sup>(2)</sup> :	± 1%
Repeat accuracy:	> 99%
Mixture ratio:	1:1 to 5:1
Min. dosing quantity:	0.01 millilitres
Volume flow <sup>(3)</sup> :	0.2 to 12 millilitres per minute

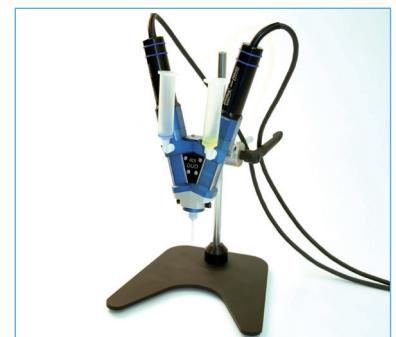
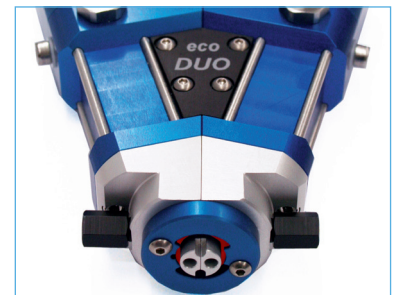

(1) Max. dosing pressure and intrinsic tightness will decrease in direct proportion to a decrease in viscosity and increase in direct proportion to an increase in viscosity. Consultation with the manufacturer recommended

(2) Volumetric dosing as absolute deviation in relation to one dispenser revolution. Depends on the viscosity of the dosing medium

(3) Volume flow depends on viscosity, primary pressure and the mixing ratio

(4) depends on the static mixer



ViscoTec Pumpen- u. Dosiertechnik GmbH  
Geschäftsfeld Komponenten & Geräte

Amperstraße 13 - D-84513 Töging a. Inn  
Tel.: +49 (0) 8631 - 9274-00  
Fax: +49 (0) 8631 - 9274-300  
info@viscotec.de  
www.viscotec.de



info@preeflow.com  
www.preeflow.com